



PUBLIC ADDRESS SYSTEM

OPERATION MANUAL

T-60DTB/120DTB/240DTB/350DTB/500DTB/650DTB MIXER AMPLIFIER WITH AUDIO SOURCES (MP3/TUNER/BLUETOOTH)



Please follow the instructions in this manual to obtain the optimum results from this unit.
We also recommend that you keep this manual handy for future reference.

TABLE OF CONTENTS

1. SAFETY PRECAUTIONS	3
2. GENERAL DESCRIPTION	5
3. FEATURES	5
4. NOMENCLATURE AND FUNCTIONS	
4.1 Front Panel	6
4.2 Remote control.....	6
4.3 Rear Panel.....	7
5. OPERATION ILLUSTRATION	8
6. TROUBLESHOOTING	10
7. APPLICATIONS	11
8. BLOCK DIAGRAM	12
9. SPECIFICATIONS	13
10. DIMENSIONAL DIAGRAM	15

1. SAFETY PRECAUTIONS

- Be sure to read the instructions in this section carefully before use.
- Make sure to observe the instructions in this manual as the conventions of safety symbols and messages regarded as very important precautions are included.
- We also recommend you keep this instruction manual handy for future reference.

Safety Symbol and Message Conventions

Safety symbols and messages described below are used in this manual to prevent bodily injury and property damage which could result from mishandling. Before operating your product, read this manual first and understand the safety symbols and messages so you are thoroughly aware of the potential safety



Indicates a potentially hazardous situation which, if mishandled, could result in death or serious personal injury.



Indicates a potentially hazardous situation which, if mishandled, could result in moderate or minor personal injury, and/or property damage.



When Installing the Unit

- Do not expose the unit to rain or an environment where it may be splashed by water or other liquids, as doing so may result in fire or electric shock.
- Use the unit only with the voltage specified on the unit. Using a voltage higher than that which is specified may result in fire or electric shock.
- Do not cut, kink, otherwise damage nor modify the power supply cord. In addition, avoid using the power cord in close proximity to heaters, and never place heavy objects -- including the unit itself -- on the power cord, as doing so may result in fire or electric shock.
- Be sure to replace the unit's terminal cover after connection completion. Because high voltage is applied to the speaker terminals, never touch these terminals to avoid electric shock.
- Be sure to ground to the safety ground (earth) terminal to avoid electric shock. Never ground to a gas pipe as a catastrophic disaster may result.
- Avoid installing or mounting the unit in unstable locations, such as on a rickety table or a slanted surface. Doing so may result in the unit falling down, causing personal injury and/or property damage.

When the Unit is in Use

- Should the following irregularity be found during use, immediately switch off the power, disconnect the power supply plug from the AC outlet and contact your nearest **ITC** dealer. Make no further attempt to operate the unit in this condition as this may cause fire or electric shock.
 - If you detect smoke or a strange smell coming from the unit.
 - If water or any metallic object gets into the unit
 - If the unit falls, or the unit case breaks
 - If the power supply cord is damaged (exposure of the core, disconnection, etc.)
 - If it is malfunctioning (no tone sounds.)
- To prevent a fire or electric shock, never open nor remove the unit case as there are high voltage components inside the unit. Refer all servicing to your nearest **ITC** dealer.
- Do not place cups, bowls, or other containers of liquid or metallic objects on top of the unit. If they accidentally spill into the unit, this may cause a fire or electric shock.
- Do not insert nor drop metallic objects or flammable materials in the ventilation slots of the unit's cover, as this may result in fire or electric shock.

CAUTION

When Installing the Unit

- Never plug in nor remove the power supply plug with wet hands, as doing so may cause electric shock.
- When unplugging the power supply cord, be sure to grasp the power supply plug; never pull on the cord itself. Operating the unit with a damaged power supply cord may cause a fire or electric shock.
- When moving the unit, be sure to remove its power supply cord from the wall outlet. Moving the unit with the power cord connected to the outlet may cause damage to the power cord, resulting in fire or electric shock. When removing the power cord, be sure to hold its plug to pull.
- Do not block the ventilation slots in the unit's cover. Doing so may cause heat to build up inside the unit and result in fire.
- Avoid installing the unit in humid or dusty locations, in locations exposed to the direct sunlight, near the heaters, or in locations generating sooty smoke or steam as doing otherwise may result in fire or electric shock.

When the Unit is in Use

- Do not place heavy objects on the unit as this may cause it to fall or break which may result in personal injury and/or property damage. In addition, the object itself may fall off and cause injury and/or damage.
- Make sure that the volume control is set to minimum position before power is switched on. Loud noise produced at high volume when power is switched on can impair hearing.
- Do not operate the unit for an extended period of time with the sound distorting. This is an indication of a malfunction, which in turn can cause heat to generate and result in a fire.
- Contact your **ITC** dealer as to the cleaning. If dust is allowed to accumulate in the unit over a long period of time, a fire or damage to the unit may result.
- If dust accumulates on the power supply plug or in the wall AC outlet, a fire may result. Clean it periodically. In addition, insert the plug in the wall outlet securely.
- Switch off the power, and unplug the power supply plug from the AC outlet for safety purposes when cleaning or leaving the unit unused for 10 days or more. Doing otherwise may cause a fire or electric shock.

An all-pole mains switch with a contact separation of at least 3 mm in each pole shall be incorporated in the electrical installation of the building.

Due to product upgrades, while some of the features and specification in the user manual does not match the actual functions, sorry for any inconvenience and thanks for your kind understanding!

2. GENERAL DESCRIPTION

It's a mixer amplifier built in Bluetooth and tuner, it adopts high-performance switching power supply and class D technology, with 1U chassis design, high efficiency, light weight, beautiful appearance.

3. FEATURES

1. Adopt high-performance switching power supply and class D technology, with 1U chassis design, high efficiency, light weight, beautiful appearance.
2. With function of MP3 module, can read MP3 files in USB flash disk, TF card. With MP3 remote control; support power-off memory function, MIC recording function.
3. Support 1 channel EMC input, 2 channels AUX input, 4 channels MIC input.
4. Each input has independent volume adjustment, with treble, bass adjustment and volume control.
5. With level indication, overload and protection indicator; support short circuit, overload and overheat protection function.
6. With mute function; microphone input priority is higher than line input; MIC1 input priority is higher than other audio input; EMC input has the highest priority.
7. Channel priority function: EMC>MIC1>MIC2/MIC3/MIC4/AUX1/AUX2/MP3.
8. Adopt advanced and high-efficiency power amplifier circuit, the speaker output is 100V or 4 ohms; rated output power is 60W, 120W, 240W, 350W, 500W, 650W.
9. Power supply is AC power , power consumption is 120W, 180W, 300W, 500W, 650W, 850W.
10. Forced air-cooling from front to back, turning it on at a constant speed, and speeding up as the temperature rises; it can meet long-term work.
11. 100V/4-16Ω output port/100V/4-16Ω speaker output switch.

4. NOMENCLATURE AND FUNCTIONS

4.1 FRONT PANEL

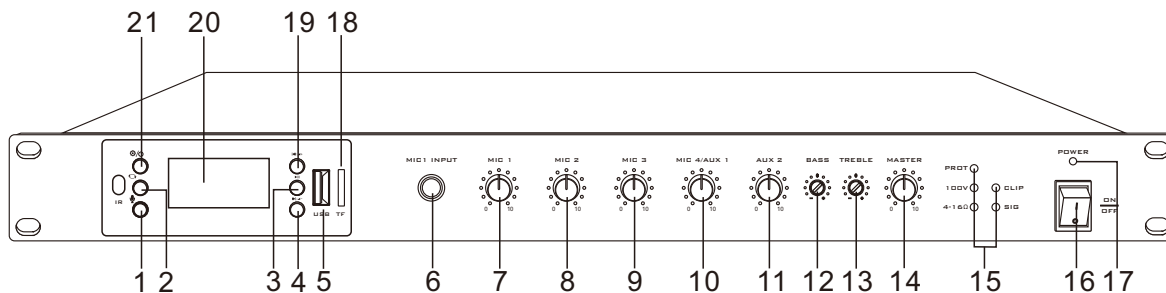

- | | |
|--------------------------------------|--|
| 1. Recording function button | 12. BASS adjustment potentiometer |
| 2. MP3 loop playback function button | 13. TREBLE adjustment potentiometer |
| 3. Play/Pause | 14. Master volume control |
| 4. Next song/Volume reduce | 15. PROT/100V/4-16Ω/CLIP/SIG status indicators |
| 5. USB interface | 16. The power switch |
| 6. MIC1 unbalanced input jack | 17. The power indicator |
| 7. MIC1 volume control knob | 18. TF card slot |
| 8. MIC2 volume control knob | 19. Previous song/Volume up |
| 9. MIC3 volume control knob | 20. LCD display |
| 10. MIC4 /AUX1 volume control knob | 21. Mode function button |
| 11. AUX2 volume control knob | |

4.2 Remote control

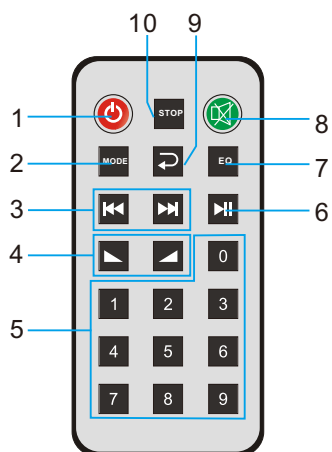

- | |
|-----------------------------|
| 1. Power switch |
| 2. Mode |
| 3. Previous/next |
| 4. Volume increase/decrease |
| 5. 0~9 number button |
| 6. Play/pause |
| 7. Sound effect control |
| 8. Mute |
| 9. Cycle play button |
| 10. Pause |

Normal usage distance of remote control:

Remote control distance: 8 meter, angle: level ± 35 , vertical ± 15 .

Remote control usage attention:

1. When install battery, please mind electrode.
2. Please let remote control aim right with window of host machine.
3. When found remote distance get short and insensitive, please change battery.
4. Please take out battery when don't use it for a long time.
5. Take it easy in case of falling.

4. NOMENCLATURE AND FUNCTIONS

4.3 REAR PANEL

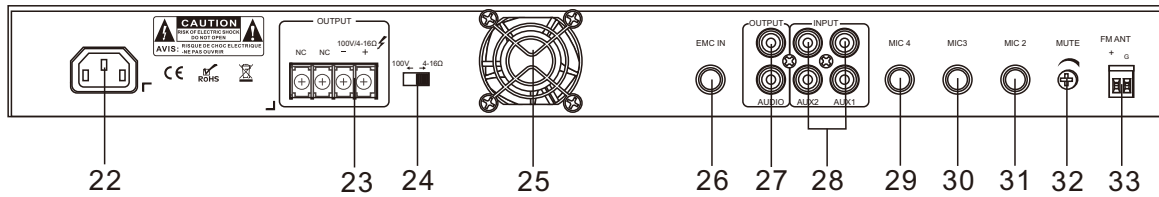

- 22. AC power input socket
- 23. 100V/4-16Ω output interface
- 24. 100V / 4-16Ω speaker output switch
- 25. Cooling fan
- 26. EMC input interface
- 27. Line output interface, used to connect the line input interface
- 28. 2 channel AUX input interface, used to connect AUX output interface
- 29. MIC4 input interface
- 30. MIC3 input interface
- 31. MIC2 input interface
- 32. MUTE mute control
- 33. FM radio antenna interface

5. OPERATION ILLUSTRATION

1. Connect the speakers:

① When the 100V and 4-16Ω selector switch to 100V position, as shown below:

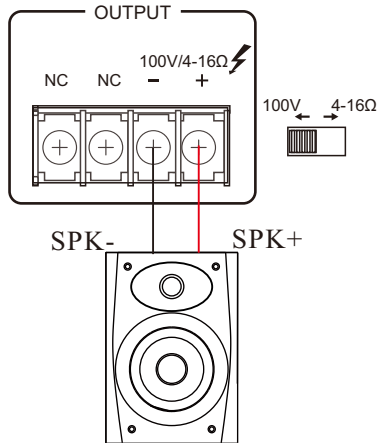

Constant pressure speaker: According to the rated power of the power amplifier, connect the constant power speaker

② When the 100V and 4-16Ω selector switch to 4-16Ω position, as shown below:

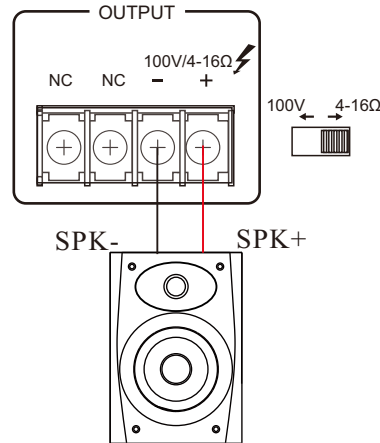

Fixed resistance speaker: 4-16Ω

Note:

1. Before connecting the speakers, please make sure that the equipment is powered off. In the case of power on, may have the risk of electric shock.
2. Please make sure there are no applied load to the speaker cables.
3. During the installation of speakers, please make sure that the sum of the rated input power of the speakers to be connected is less than rated power of equipment.

2. Connect external devices:

- ① Please ensure that the equipment and all equipment will be connected are powered off.
- ② Using the corresponding cable to connect this equipment and other external equipment.

3. Connect the power line and turn it on:

- ① Please make sure that the power switch of equipment and its connected equipment are turned off (in the OFF position).
- ② Turn the volume knob to the left
- ③ Connect the supplied power line to the AC IN interface
- ④ Plug the power line into the applicable socket
- ⑤ Turn on the connected equipment (CD player, etc.), and then turn on the equipment.

Note:

1. Before powering on, please check and make sure there is no problem with the cable and connection.
2. When you turn off the system, turn off the equipment, and then turn off the connected equipment.

5. OPERATION ILLUSTRATION

4. Microphone using:

1. Turning the volume knob to the left, Connect the microphone and microphone input interface.
2. Turning the volume knob in the right position.
3. Facing the microphone and Speak loudly, turn the volume knob to the right, until the output signal no longer distortion. If input is high but output is low voice, and then increase the volume by using the volume knob. If the speaker volume is very high, then reduce the volume by using the volume knob.

5. Shutdown the system:

1. Turning the volume knob to the left until the minimum position.
2. Turning off the panel power switch of the professional power amplifier, at Off. In turn shutoff processor equipment and audio source equipment.





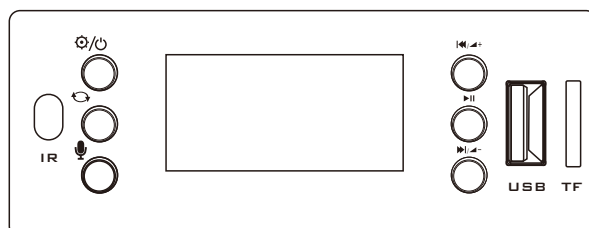

Note:

1. Turn off the power switch, Please wait about 5 seconds before turning on again. Continuous rapid turning on and off the power switch, it will lead to equipment failure.
2. Even the switch is in the off status, there will be a little current in equipment. If it won't use the equipment in a long time, please unplug the power cord from the wall AC socket.

6. Built-in MP3 player operation method:



The buttons are explained as follows:

S.No	Buttons	Function
1		Mode function button; FM / USB / BT / playing (Long press this button to forcibly turn on / off the machine)
2		Previous song (long press to increase volume)
3		Mp3 loop playback function button; (with Repeat One / Repeat ALL / Random / Repeat Folder mode.)
4		Play / Pause (long press this button in FM mode to receive the station)
5		Recording function button; (press this button in PLAYING mode to record) (Long press the Record button to switch between recording and USB playback)
6		Next song (long press to decrease volume)

USB function

Press the MODE button to select the USB mode, copy the MP3 file in the U disk (below 32G), and it supports MP3 / WAV / WMA / AEC / FLAC format.

TF card function

Insert a TF card (below 32G) to copy the MP3 file, and it supports MP3 / WAV / WMA / AEC / FLAC format.

5. OPERATION ILLUSTRATION

FM (Radio reception) function

Press the MODE button to select the FM mode, and then long press the PLAY / PAUSE button to automatically receive the radio station. The radio stations received (depending on the sound received) depends on the venue.

Bluetooth function

Press the MODE button to select the Bluetooth mode, turn on the mobile phone Bluetooth for connecting, it can play normally when the mobile phone is 10 meters barrier-free away. Bluetooth default name is "BP10_BT".

MP3 song loop playback

In USB or TF card mode, play a song at will, press the mode button to switch between REPEAT One / REPEAT ALL / Random / REPEAT Folder.

Functional memory function

You can turn it off by the remote controller or long pressing the MODE button. After it is turned on, it can remember the function mode selected before. If you unplug the power cable and turn it on again, the default is Bluetooth function mode.

Volume +/-

Long press the Previous Song button to increase the volume quickly, and long press the Next Song button to decrease the volume quickly.

6. TROUBLESHOOTING

Failure phenomena	Failure cause
1. Power switch is not opened	<ol style="list-style-type: none">1. Power line is cut off2. The protection function of the equipment is not activated
2. All lines are connected, but there is no sound.	<ol style="list-style-type: none">1. The power switch is not opened or the power plug is bad contacted.2. The fuse is burnt3. The volume knob is not opened or turned down to a extra low level4. There is no audio signal input5. There is short-circuit in the speaker line.
3. The sound suddenly disappears in normal status.	<ol style="list-style-type: none">1. The equipment is in very high temperature to make it into protection status.2. The connection wire is bad contact.
4. Low sound	The equipment is set to be low impedance connection, but the speakers connected is with high impedance.
5. Sound is distorted	The input level of Mic or external equipment is too high

7. APPLICATIONS

REAR PANEL CONNECTIONS

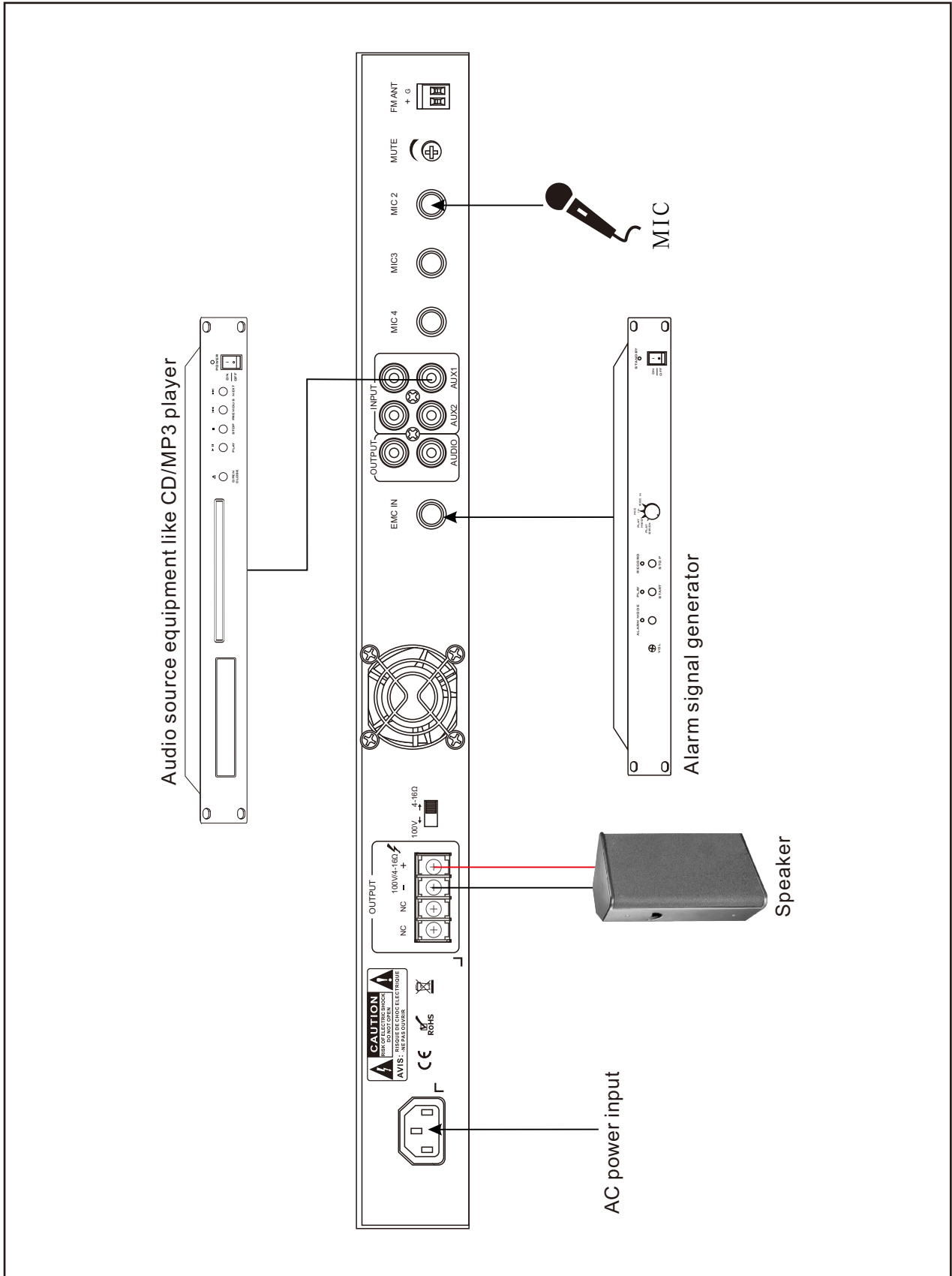

8. BLOCK DIAGRAM

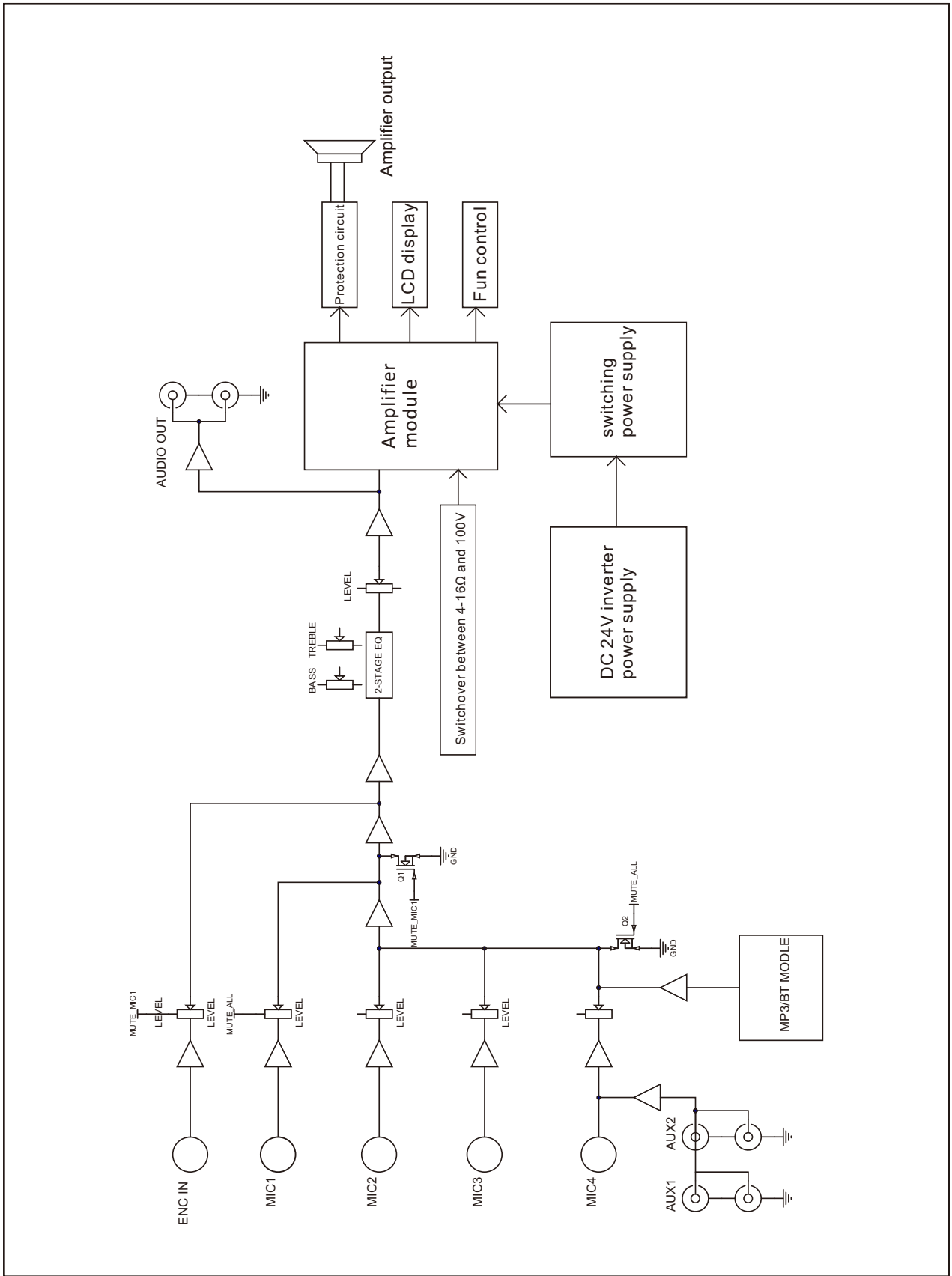

9. SPECIFICATIONS

Model	T-60DTB	T-120DTB	T-240DTB
Rated Power	60W	120W	240W
Output Level	4-16Ω/100V		
Input Sensitivity	MIC1, 2, 3, 4 Input: 5mV/600Ω unbalanced 6. 3 PHONE JACK connection terminal; AUX1, 2 Input: 350mV/10KΩ unbalanced RCA connection terminal; EMC input: 775mV/10KΩ unbalanced 6. 3 PHONE JACK connection terminals		
Output Sensitivity & Impedance	MIX OUT: 1000mV/470Ω unbalanced RCA connection terminal		
Tones	Bass: ±10dB at 100Hz Treble: ±10dB at 10KHz		
Frequency Response	80Hz~16KHz (+1dB, -3dB)		
Cross talk attenuation	≥50dB		
SNR S/N Ratio	MIC1, 2, 3: 66dB; AUX1, 2: 80dB		
THD	≤0.05% (at 1KHz, 1/3 rated power)		
Indicator	Power indicator		
Cooling Mode	Air cooling		
Protection Mode	Short circuit, overload and overheating protection		
Operation Temperature	+5°C~+40°C		
Storage Temperature	-20°C~+70°C		
Relative Humidity	<95% (No condensation)		
Voltage	<input type="checkbox"/> ~110V 50Hz <input type="checkbox"/> ~110V 60Hz <input type="checkbox"/> ~120V 50Hz <input type="checkbox"/> ~120V 60Hz <input type="checkbox"/> ~220V 50Hz <input type="checkbox"/> ~220V 60Hz <input type="checkbox"/> ~230V 50Hz <input type="checkbox"/> ~230V 60Hz <input type="checkbox"/> ~240V 50Hz <input type="checkbox"/> ~240V 60Hz		
Power Consumption	120W	180W	300W
Weight	3.9Kg	4Kg	4.1Kg
Dimension	484×315×44mm		

9. SPECIFICATIONS

Model	T-350DTB	T-500DTB	T-650DTB
Rated Power	350W	500W	650W
Output Level	4-16Ω/100V		
Input Sensitivity	MIC1, 2, 3, 4 Input: 5mV/600Ω unbalanced 6. 3 PHONE JACK connection terminal; AUX1, 2 Input: 350mV/10KΩ unbalanced RCA connection terminal; EMC input: 775mV/10KΩ unbalanced 6. 3 PHONE JACK connection terminals		
Output Sensitivity & Impedance	MIX OUT: 1000mV/470Ω unbalanced RCA connection terminal		
Tones	Bass: ±10dB at 100Hz Treble: ±10dB at 10KHz		
Frequency Response	80Hz~16KHz (+1dB, -3dB)		
Cross talk attenuation	≥50dB		
SNR S/N Ratio	MIC1, 2, 3: 66dB; AUX1, 2: 80dB		
THD	≤0.05% (at 1KHz, 1/3 rated power)		
Indicator	Power indicator		
Cooling Mode	Air cooling		
Protection Mode	Short circuit, overload and overheating protection		
Operation Temperature	+5°C~+40°C		
Storage Temperature	-20°C~+70°C		
Relative Humidity	<95% (No condensation)		
Voltage	<input type="checkbox"/> ~110V 50Hz <input type="checkbox"/> ~110V 60Hz <input type="checkbox"/> ~120V 50Hz <input type="checkbox"/> ~120V 60Hz <input type="checkbox"/> ~220V 50Hz <input type="checkbox"/> ~220V 60Hz <input type="checkbox"/> ~230V 50Hz <input type="checkbox"/> ~230V 60Hz <input type="checkbox"/> ~240V 50Hz <input type="checkbox"/> ~240V 60Hz		
Power Consumption	500W	650W	850W
Weight	4.2Kg	4.3Kg	4.4Kg
Dimension	484×315×44mm		

10. DIMENSIONAL DIAGRAM

UNIT:mm

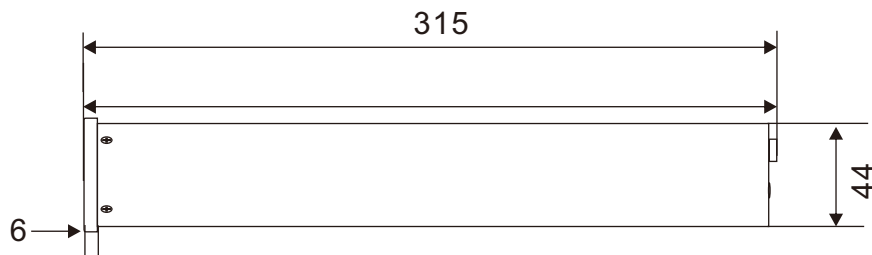
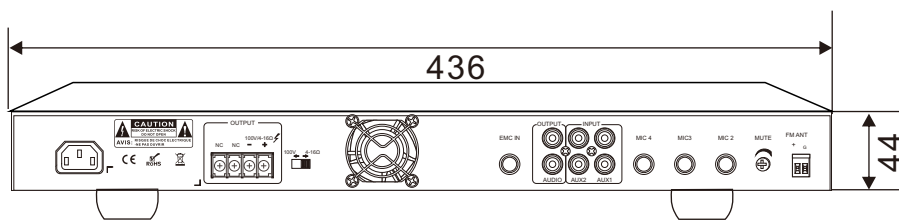
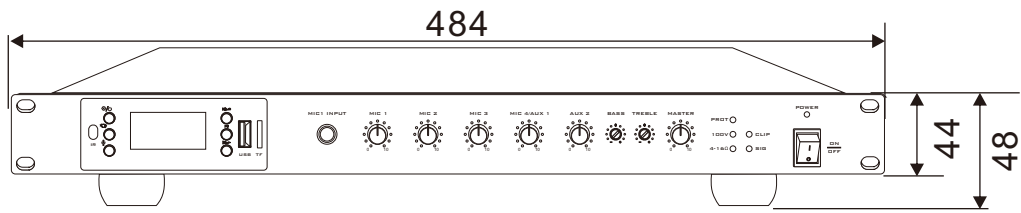

Keep the unit's all sides over 10 cm away from objects that may obstruct air flow to prevent the unit's internal temperature rise.

UNIT:mm

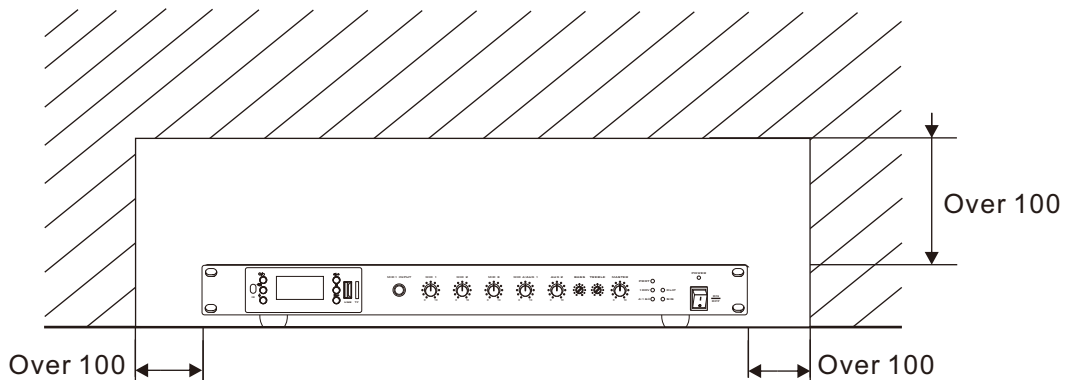

PUBLIC ADDRESS SYSTEM

